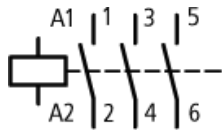
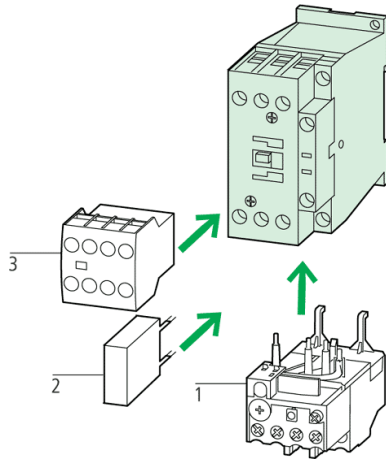

Type: **DILM150(RAC240)**

 Article No.: **239588**

 Sales text **Contacto**r,75kW/400V,AC operated

Ordering information			
Connection technique			Screw terminals
Description			3 pole
Description			Springloaded terminals on the auxiliary and control circuit terminals
Rated operational current			
AC-3 380 V 400 V	$I_e$	A	150
Max. rating for three-phase motors, 50 – 60 Hz			
AC-3 220 V 230 V	$P$	kW	48
AC-3 380 V 400 V	$P$	kW	75
AC-3 660 V 690 V	$P$	kW	96
AC-4 220 V 230 V	$P$	kW	20
AC-4 380 V 400 V	$P$	kW	33
AC-4 660 V 690 V	$P$	kW	48
Conventional free air thermal current $I_{th}$ = $I_e$ AC-1 at 60 °C			
Open	$I_{th} = I_e$	A	160
Contacts			
Can be combined with auxiliary contact			DILM150-XHI(V).. DILM1000-XHI(V)..

**Contact sequence****Notes concerning the product group****Accessories**

- 1 Overload relay → [278442](#)
- 2 Suppressor → [281199](#)
- 3 Auxiliary contact module → [277376](#)
- Further actuating voltages → [277379](#)
- Accessories → [281227](#)

The DC operated contactors have integral suppressor circuits (DILM7 – DILM15: Varistor).

Contactors DILM115, DILM150 and DILM170 have a built-in suppressor circuit.

Mirror contact for DILM7–01 to DILM32–01

Contactor contact according to EN 50012

**General**

Standards			IEC/EN 60947, VDE 0660, UL, CSA
Lifespan, mechanical			

AC operated	Operations	$\times 10^6$	10
DC operated	Operations	$\times 10^6$	10
Operating frequency, mechanical			
AC operated	Operations/h		3600
DC operated	Operations/h		3600
Climatic proofing			Damp heat, constant, to IEC 60068-2-78 Damp heat, cyclical, to IEC 60068-2-30
Ambient temperature			
Open		°C	-25...60
Enclosed		°C	-25...40
Storage		°C	... 40...+80
Mechanical shock resistance (IEC/EN 60068-2-27)			
Half-sinusoidal shock, 10 ms			
Main contacts			
N/O contact		g	10
Auxiliary contacts			
N/O contact		g	7
N/C contact		g	5
Mechanical shock resistance (IEC/EN 60068-2-27) when tabletop-mounted			
Half-sinusoidal shock, 10 ms			
Main contacts			
Thickness of material for busbar max.		g	10
Auxiliary contacts			
Min. rated current = rated uninterrupted current		g	7
N/C contact		g	5
Protection type			IP00
Protection against direct contact when actuated from front (IEC 536)			Finger- and back-of-hand proof
Weight			
AC operated		kg	2
DC operated		kg	2,1
Terminal capacity main cable			
Flexible with ferrule		mm <sup>2</sup>	1 × (10 – 95) 2 × (10 – 70)

Stranded		mm <sup>2</sup>	1 × (16 – 95) 2 × (16 – 70)
Solid or stranded		AWG	8...3/0
Flat conductor	Number of segments × width × thickness	mm	2 × (6 × 16 × 0.8)
Main cable connection screw/bolt			M10
Tightening torque		Nm	14
Terminal capacity control circuit cables			
Solid		mm <sup>2</sup>	1 × (0.75 – 4) 2 × (0.75 – 4)
Flexible with ferrule		mm <sup>2</sup>	1 × (0.75 – 2.5) 2 × (0.75 – 2.5)
Solid or stranded		AWG	18 – 14
Control circuit cable connection screw/bolt			M3.5
Tightening torque		Nm	1.2
Tool			
Main cable			
Hexagon socket–head spanner	SW	mm	5
Control circuit cables			
Pozidriv screwdriver		Size	2
Standard screwdriver		mm	0.8 × 5.5 1 × 6
Terminal capacity control circuit cables			
Solid		mm <sup>2</sup>	1 × (0.75 – 2.5) 2 × (0.75 – 2.5)
Flexible		mm <sup>2</sup>	1 × (0.75 – 2.5) 2 × (0.75 – 2.5)
Flexible with ferrule		mm <sup>2</sup>	1 × (0.75 – 1.5) 2 × (0.75 – 1.5)
Solid or stranded		AWG	18 – 14
Tool			
Stripping length		mm	10
Screwdriver blade width		mm	3,5
<b>Main conducting paths</b>			
Rated impulse withstand voltage	$U_{imp}$	V AC	8000
Overtoltage category/pollution degree			III/3

Rated insulation voltage	$U_i$	V AC	1000
Rated operational voltage	$U_e$	V AC	1000
Safe isolation to VDE 0106 Part 101 and Part 101/A1			
between coil and contacts		V AC	690
between the contacts		V AC	690
Making capacity (p.f. to IEC/EN 60947)			
	Up to 690 V	A	2100
Breaking capacity			
220/230 V		A	1500
380/400 V		A	1500
500 V		A	1500
660/690 V		A	1200
Short-circuit rating			
Short-circuit protection maximum fuse			
Type "2" coordination			
400 V	gG/gL 500 V	A	250
690 V	gG/gL 690 V	A	250
Type "1" coordination			
400 V	gG/gL 500 V	A	250
690 V	gG/gL 690 V	A	250
<b>AC</b>			
AC-1 duty			
conv. therm. current 3 pole 50 – 60 Hz			
open			
at 40 °C	$I_{th}$	A	190
at 50 °C	$I_{th}$	A	180
at 55 °C	$I_{th}$	A	170
at 60 °C	$I_{th}$	A	160
enclosed	$I_{th}$	A	144
Conventional free air thermal current, 1 pole			
open	$I_{th}$	A	400
enclosed	$I_{th}$	A	360
AC-3 duty			
Rated operational current AC-3 open, 50 – 60 Hz, 3 pole			

220/230 V	$I_e$	A	150
240 V	$I_e$	A	150
380/400 V	$I_e$	A	150
415 V	$I_e$	A	150
440V	$I_e$	A	150
500 V	$I_e$	A	150
660/690 V	$I_e$	A	100
Motor rating			
220/230 V	$P$	kW	48
240V	$P$	kW	52
380/400 V	$P$	kW	75
415 V	$P$	kW	91
440 V	$P$	kW	95
500 V	$P$	kW	110
660/690 V	$P$	kW	96
AC–4 duty			
Rated operational current AC–4 open, 50 – 60 Hz, 3 pole			
220/230 V	$I_e$	A	65
240 V	$I_e$	A	65
380/400 V	$I_e$	A	65
415 V	$I_e$	A	65
440 V	$I_e$	A	65
500 V	$I_e$	A	65
660/690 V	$I_e$	A	50
Motor rating			
220/230 V	$P$	kW	20
240 V	$P$	kW	22
380/400 V	$P$	kW	33
415 V	$P$	kW	39
440 V	$P$	kW	41
500 V	$P$	kW	47
660/690 V	$P$	kW	48
<b>DC</b>			
of three–phase capacitors open			
DC–1 operation			
60 V	$I_e$	A	160
110 V	$I_e$	A	160
220 V	$I_e$	A	90

440 V	$I_e$	A	4,5
DC-3 operation			
60 V	$I_e$	A	160
110 V	$I_e$	A	160
220 V	$I_e$	A	40
440 V	$I_e$	A	1
DC-5 operation			
60 V	$I_e$	A	160
110 V	$I_e$	A	160
220 V	$I_e$	A	40
440 V	$I_e$	A	1
<b>Current heat loss (3 pole)</b>			
Current heat loss at $I_{th}$		W	30,7
Current heat loss at $I_e$ to AC-3/400 V		W	27
Impedance per pole		m	0,4
<b>Magnet systems</b>			
Voltage tolerance			
AC operated	Pick-up	$\times U_c$	0,8...1,15
Drop-out voltage AC operated	Drop-out	$\times U_c$	0,25...0,6
DC operated	Pick-up	$\times U_c$	0,7...1,2
DC operated	Drop-out	$\times U_c$	0,15...0,6
Power consumption of the coil in a cold state and $1.0 \times U_c$			
50 Hz	Pick-up	VA	180
50 Hz	Sealing	VA	3,1
50 Hz	Sealing	W	2,1
60 Hz	Pick-up	VA	170
60 Hz	Sealing	VA	3,1
60 Hz	Sealing	W	2,1
50/60 Hz	Pick-up	VA	170 170
50/60 Hz	Sealing	VA	3,1 3,1
50/60 Hz	Sealing	W	2,1 2,1
DC operated	Pick-up	W	149
DC operated	Sealing	W	2.1
Duty factor		% DF	100
Switching times at 100 % $U_c$ (approximate values)			

Main contacts			
AC operated			
Closing delay		ms	28...33
Opening delay		ms	35...41
DC operated			
Closing delay		ms	35
Opening delay		ms	30
Arcing time		ms	15
Permissible residual current with actuation of A1 – A2 by the electronics (with 0 signal).		mA	1

### Electromagnetic compatibility (EMC)

Emitted interference			to EN 60947–1
Interference immunity			to EN 60947–1

### Notes

<b>Notes</b>			<p>The following applies to magnet systems, voltage tolerance, pickup voltage DC-operated DILM17 – DILM32:</p> <p>RDC 24 (Umin 24 V DC/Umax 27 V DC)  RDC 60 (Umin 48 V DC/Umax 60 V DC)  RDC 130 (Umin 110 V DC/Umax 130 V DC)  RDC 240 (Umin 200 V DC/Umax 240 V DC)</p> <p>Example:  <math>U_c = 0.7 \times U_{min} - 1.2 \times U_{max}</math>  <math>U_c = 0.7 \times 24 \text{ V} - 1.2 \times 27 \text{ V DC}</math></p> <p>With voltage tolerance and DC operated power consumption the following applies: At least smoothed double-pulse bridge rectification or a three-phase current rectifier is necessary</p>
--------------	--	--	--

### Mounting position, AC- and DC operated



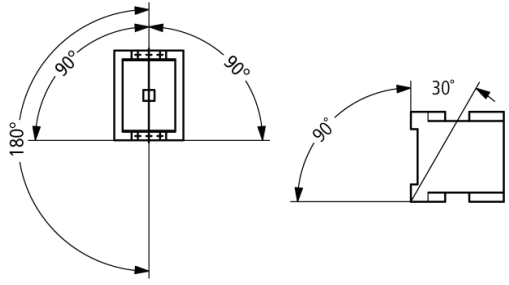

---

## Dimensions

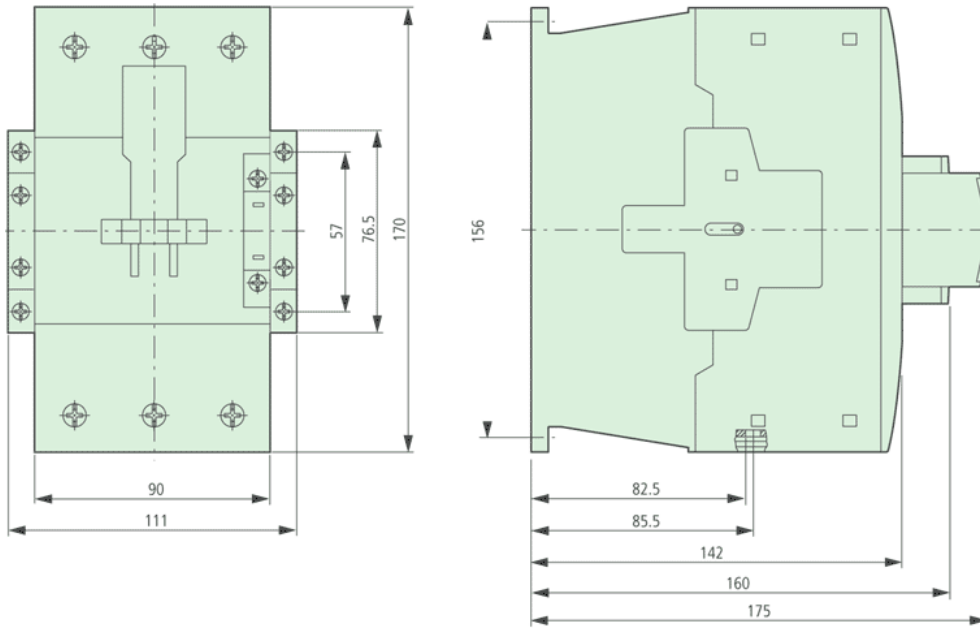

---

## Dimensions

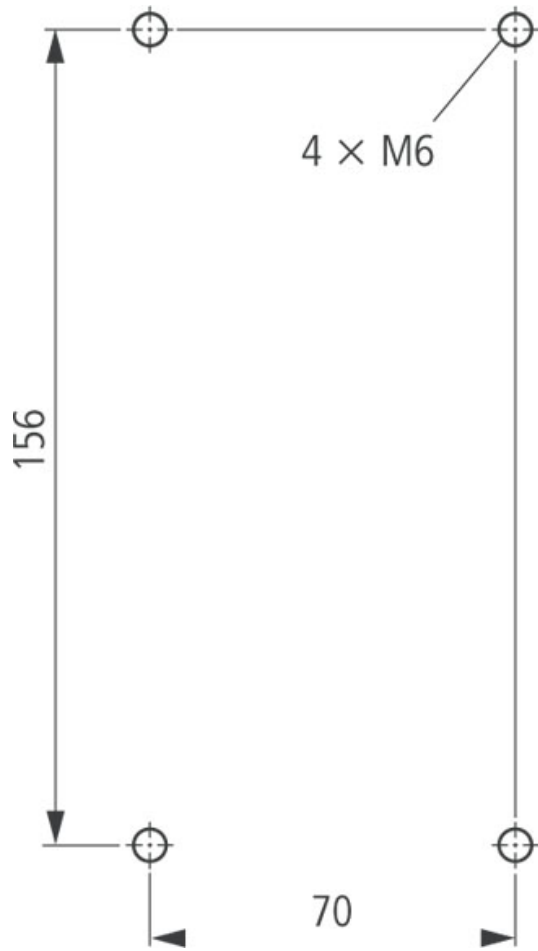

---

distance at side to earthed parts: 10 mm

---

Basic unit with auxiliary contact module

---

**Characteristic curve**

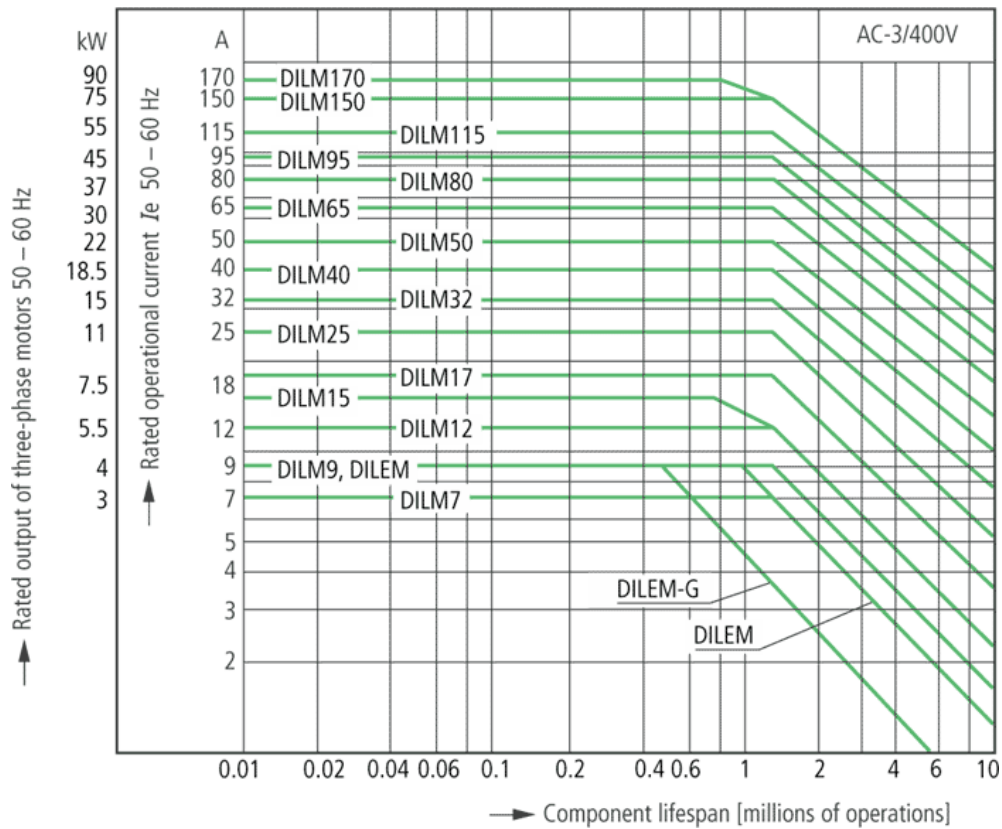

- Squirrel-cage motor
- Operating characteristics
- Starting: from rest
- Stopping: after attaining full running speed
- Electrical characteristics
- Make: up to  $6 \times$  rated motor current
- Break: up to  $1 \times$  rated motor current
- Utilization category
- 100 % AC-3
- Typical applications
- Compressors
- Lifts
- Mixers
- Pumps
- Escalators
- Agitators
- Fans
- Conveyor belts
- Centrifuges
- Hinged flaps
- Bucket-elevators
- Air conditioning system
- General drives in manufacturing and processing machines

### Characteristic curve

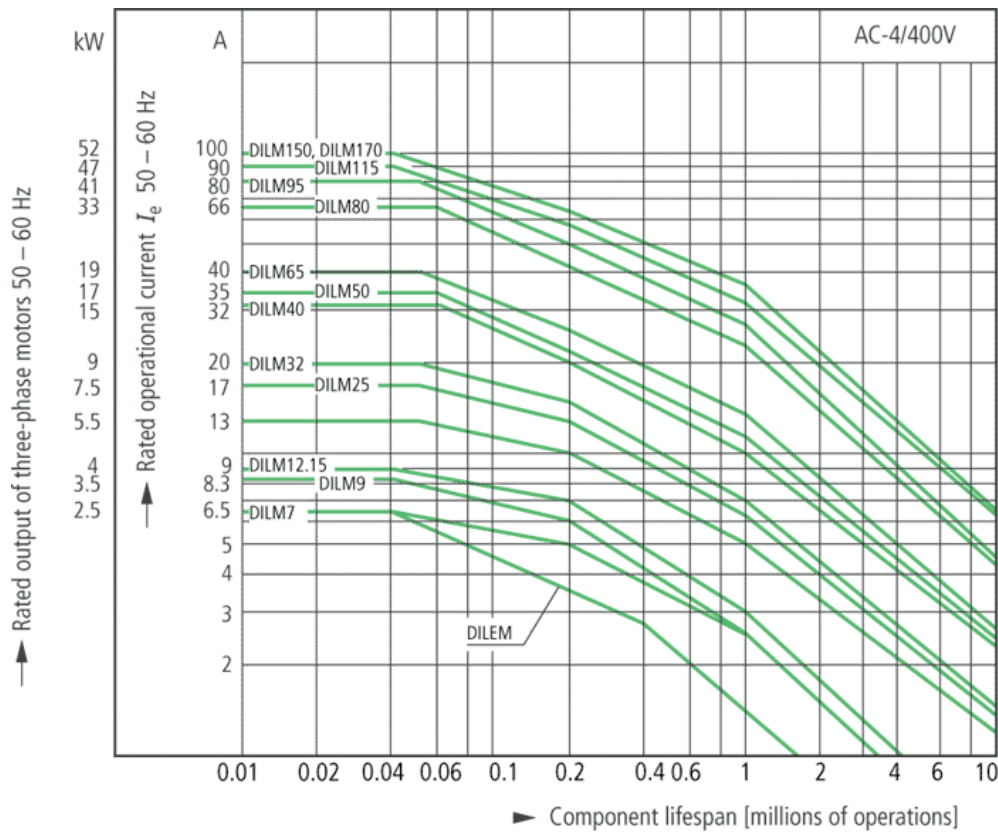

- Extreme switching duty
- Squirrel-cage motor
- Operating characteristics
- Inching, plugging, reversing
- Electrical characteristics
- Make: up to 6 × rated motor current
- Break: up to 6 × rated motor current
- Utilization category
- 100 % AC-4
- Typical applications
- Printing presses
- Wire-drawing machines
- Centrifuges
- Special drives for manufacturing and processing machines

Moeller GmbH, Hein-Moeller-Str. 7-11, D-53115 Bonn  
 E-Mail: [catalog@moeller.net](mailto:catalog@moeller.net), Internet: [www.moeller.net](http://www.moeller.net), <http://catalog.moeller.net>  
 Copyright 2006 by Moeller GmbH. HPL-C2007G V2.1